

Crownline Cabinets Provide A Wide Selection of Door Styles, Glazing and Sizes. These Durable Cabinets are Designed to Industry Standards for Fire Department Valves, Fire Hose Rack Units and Extinguishers. This Version with Concealed Trim is Designed to be Installed Over Drywall, or Under Plaster for a Flush Finished Surface.

Door & Trim: Clear anodized aluminum. 1-3/4" Trim on door. These flush cabinet doors are mounted in a 5/8" door stop, are attached by a continuous hinge and are equipped with zinc-plated handle and roller catch for all non-locking doors. Theft-deterrent SAF-T-LOK™ also available.

Concealed Flange Style: Drywall bead for installation over drywall or plaster flange with stop with 3/4" plaster allowance. All meet the 4" ADA cabinet projection requirement.

Tub: The tub is constructed of cold rolled steel with silver powder-coat finish standard. Tub includes a 1-1/4" wide flange to cover the all opening, and is designed to be concealed by drywall, plaster or stucco.

Knockouts: K.O.'s are provided on both sides of the cabinet. K.O.'s on left side will be located using "J" dimension, K.O.'s on right side using "K" dimension and may be offset from K.O.'s on "J" side of cabinet. Models 6024 & 6224 - Specify knockout location. Custom location K.O.'s available.

Special Features: Model 8024 has a shelf 12" from the bottom of the cabinet and are designed to hold a fire extinguisher plus FD valve or other accessory. That model can also be ordered without shelf to allow for lower mounting height of valve piping to meet NFPA14.

Fire-Rated Option Available: Yes - See separate submittal.

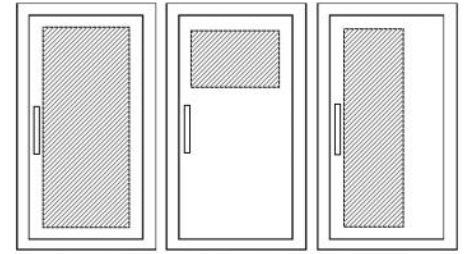
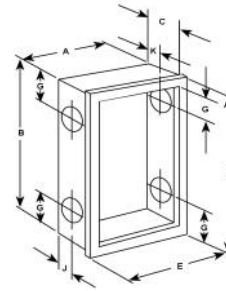

F - Full glass with pull
G - Full glass with pull handle and Saf-T-Lok (Not Shown)
D - Horizontal duo panel with pull
E - Horizontal duo panel with pull and Saf-T-Lok. (Not Shown)
V - Vertical duo panel with pull
W - Vertical duo panel with pull and Saf-T-Lok. (Not Shown)

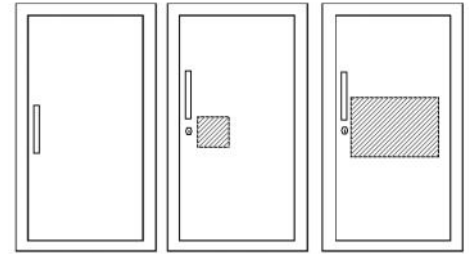

S21 - Solid with pull
L22 - Solid with pull and Saf-T-Lok
L24 - Solid with cylinder key lock/no pull (L22,24 not shown)
B10 - Acrylic view window with pull, and Saf-T-Lok
A - Center duo panel with pull and Saf-T-Lok

STEP 1: SELECT MODEL NUMBER, TRIM & QUANTITY (Refer to Chart on Page 2)

STEP 2: SELECT DOOR STYLE

(Check one box below)

- | | |
|--|---|
| <input type="checkbox"/> F Full Glazing | <input type="checkbox"/> L22 Solid with SAF-T-LOK |
| <input type="checkbox"/> G Full Glazing with SAF-T-LOK™ | <input type="checkbox"/> V Vertical Duo |
| <input type="checkbox"/> D Horizontal Duo Panel | <input type="checkbox"/> W Vertical Duo with SAF-T-LOK |
| <input type="checkbox"/> E Horizontal Duo Panel with SAF-T-LOK | <input type="checkbox"/> B10 Acrylic View Window with SAF-T-LOK |
| <input type="checkbox"/> A Center Duo Panel with SAF-T-LOK | <input type="checkbox"/> L24 Solid with Cylinder Lock & No Handle |
| <input type="checkbox"/> S21 Solid Door | |

ADA Cabinet Mounting Height: Standard Pull on G, E, W, L22, A and B Door Styles with Saf-T-Lok are 3 5/8" Higher than Door Center, so Allow for that When Mounting Cabinet. Standard Pull with No Lock or ADA Recessed Pull are Centered on Door.

STEP 3: SELECT DOOR GLAZING

(Check one box below)

- | | |
|---|--|
| <input type="checkbox"/> 10 Clear Acrylic | <input type="checkbox"/> 16 Gray Acrylic |
| <input type="checkbox"/> 13 Clear Wire Glass with Safety Film | <input type="checkbox"/> 17 Clear Tempered Glass |
| <input type="checkbox"/> 15 Bronze Acrylic | <input type="checkbox"/> 18 Laminated Safety Glass |

STEP 4: OPTIONAL FEATURES AT ADDITIONAL COST:

- | | | |
|---|---|--|
| <input type="checkbox"/> Dark Bronze Anodized Door & Trim (pull to match) | <input type="checkbox"/> PUCH Polished Chrome Handle | <input type="checkbox"/> Black Vertical FE Letters LDCVBFE |
| <input type="checkbox"/> Aluminum Tub - Clear Anodized | <input type="checkbox"/> FDVO Decal Fire Department Valve Octagonal 6 x 6" | <input type="checkbox"/> Red Vertical FE Letters LDCVRFE |
| <input type="checkbox"/> Optional Tub Color: ___ Black ___ Red | <input type="checkbox"/> 1403 Decal Fire Hose Black/Red Horiz. Letters 4 x 9 | <input type="checkbox"/> White Vertical FE Letters LDCVWFE |
| <input type="checkbox"/> Futura "Fire" Handle ___ Mill ___ Red ___ White | <input type="checkbox"/> LDCHRFDV-R Diecut Fire Dept. Valve Horiz. 10-1/4 x 4-3/8 | <input type="checkbox"/> Black Horizontal FE Letters LDCHBFE |
| <input type="checkbox"/> PRH Recessed Pull Handle | <input type="checkbox"/> LDCVRFDV Diecut Fire Dept Valve Vert. 3/4" x 21 1/2" | <input type="checkbox"/> Red Horizontal FE Letters LDCHRFE |
| <input type="checkbox"/> SA Strobe Alarm (surface mount models) | <input type="checkbox"/> LDCVRFDV-R Diecut Fire Dept Valve Vert. Revers. 3/4" x 21 1/2" | <input type="checkbox"/> White Horizontal FE Letters LDCHWFE |
| <input type="checkbox"/> CA Commander Alarm | <input type="checkbox"/> LDCHRFDV Diecut Fire Department Valve Ascend. 1" x 17" | |
| <input type="checkbox"/> BA Brigadier Alarm | <input type="checkbox"/> LDCVRFSCV-R Diecut Fire Sprinkler Cont. Valve Vert 3/4" x 18" | |
| <input type="checkbox"/> No Shelf for 8000 Series | <input type="checkbox"/> Etched or Engraved Lettering-Check here and attach separate submittal. | |

Fire Hose Racks - See separate submittal

 JL INDUSTRIES	Distributor:	Quantity:
	Contractor:	Approved By:
	Model #:	Architect:
	Project:	Date:

©2023 ACTIVAR CONSTRUCTION PRODUCTS GROUP, INC.

HEADQUARTERS: 9702 NEWTON AVE S, BLOOMINGTON, MN 55431 PH: 800-554-6077 EMAIL: SALES@ACTIVARCPG.COM WWW.ACTIVARCPG.COM
MANUFACTURING: BLOOMINGTON, MN & COMMERCE, CA WAREHOUSES: SEE WEBSITE FOR LOCATIONS 5/3/2023

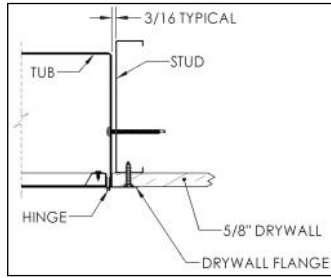
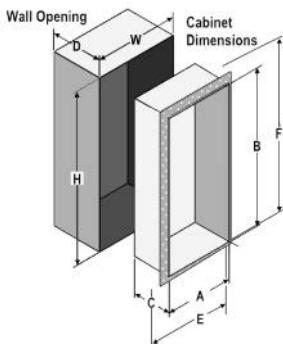

TRIMLESS FLANGE FOR 5/8" DRYWALL (W)

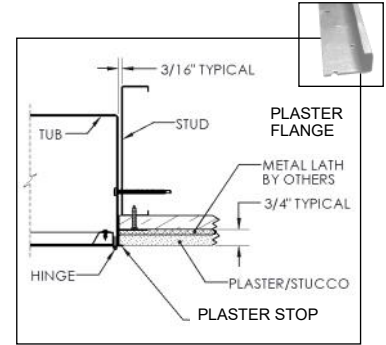
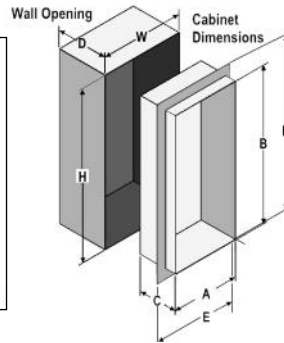

TRIMLESS RECESSED FLANGE FOR 3/4" PLASTER (P)

QTY	#	TUB I.D. W x H x D in Inches			FRAME O.D.		RECESSED WALL OPENING			KNOCKOUT LOCATIONS			RECOMMENDED HOSE RACK, FIRE DEPARTMENT VALVES & EXTINGUISHERS
		A	B	C	E	F	Width	Height	Depth	J	G	K	
TRIMLESS CABINET WITH WALLBOARD BEAD TRIM FOR INSTALLATION OVER DRYWALL - Example of Part # 6024WF10													
	6024W	24	30	6	26 1/2	32 1/2	25	31	6 1/8	2 1/2	4	2 1/2	HOSE RACK: 1- 1/2" x 1-1/2" Hose Rack Unit with 50 or 75' Hose (HRA:050B, 050CH, 075B, 075CH) & Cosmic 2½ or Galaxy 2½- 5 lb Extinguisher
	6224W	24	34 3/4	6	26 1/2	36 1/4	25	35 3/4	6 1/8	2 1/2	4	2 1/2	HOSE RACK: 1- 1/2" x 1-1/2" Hose Rack Unit - 100' Hose (HRA 100B, HRA100CH) & Cosmic 2½ or Galaxy 2½- 5 lb Extinguisher
	6124W	24	30	8	26 1/2	32 1/2	25	31	8 1/8	4	4	4	HOSE RACK: 2-1/2" x 1-1/2" Hose Rack Unit 50 or 75' Hose (HRA050B-2.5, HRA075B-2.5)
	6424W	24	34 3/4	8	26 1/2	36 1/4	25	35 3/4	8 1/8	4	4	4	HOSE RACK: 2-1/2" x 1-1/2" Hose Rack Unit 100' Hose (HRA100B-2.5)
	6624W	24	38 3/4	8	26 1/2	41 1/4	25	39 3/4	8 1/8	4	4	4	HOSE RACK: 2-1/2" x 1-1/2" Hose Rack Unit 125' Hose (HRA125B-2.5)
	6324W	30	30	8	32 1/2	32 1/2	31	31	8 1/8	4	4	4	HOSE RACK & FD VALVE OR EXTINGUISHER: 1-1/2" OR 2-1/2" Valve 50' or 75' Hose Rack Unit Plus FD Valve or Cosmic or Galaxy Extinguisher
	6524W	32 3/4	34 3/4	8	35 1/4	36 1/4	33 3/4	35 3/4	8 1/8	4	4	4	HOSE RACK & FD VALVE OR EXTINGUISHER: 1-1/2" OR 2-1/2" Valve, 100' Hose Rack Unit Plus FD Valve or Cosmic or Galaxy Extinguisher
	7224W	32 3/4	38 3/4	8	35 1/4	41 1/4	33 3/4	39 3/4	8 1/8	4	4	4	HOSE RACK & FD VALVE OR EXTINGUISHER: 1-1/2" OR 2-1/2" Valve, 125' Hose Rack Unit Plus FD Valve or Cosmic or Galaxy Extinguisher
	8524W	18	18	8	21 1/8	21 1/8	19	19	8 1/8	4	9	4	FIRE DEPARTMENT VALVE: 1-1/2" or 2-1/2" Fire Department Valve with Cap and Chain
	8424W	18	18	10	21 1/8	21 1/8	19	19	10 1/8	5	9	5	
	8724W	26	26	8	28 1/2	28 1/2	27	27	18 1/8	4	13	4	DUAL SIDE BY SIDE FIRE DEPARTMENT VALVE & EXTINGUISHER OR 2 FIRE DEPARTMENT VALVES: 1-1/2" or 2-1/2" FD Valve w/Cap and Chain Plus Cosmic & Galaxy 2.5-10 Fire Extinguisher
	8624W	26	26	10	28 1/2	28 1/2	27	27	10 1/8	5	13	5	
	8024W	16	40	9	18 1/2	42 1/2	17	41	9 1/8	4 1/4	6	4 1/4	DUAL EXTINGUISHER & FD VALVE CABINET W/SHELF: Shelf is 12" from bottom. Cosmic or Galaxy Extinguisher
TRIMLESS CABINET WITH RECESSED FLANGE FOR INSTALLATION OF 3/4" PLASTER OVER TRIM - Example of Part # 6024PF10													
	6024P	24	30	6	26 1/2	32 1/2	25	31	6 1/8	2 1/2	TBD	2 1/2	HOSE RACK: 1- 1/2" x 1-1/2" Hose Rack Unit with 50 or 75' Hose (HRA:050B, 050CH, 075B, 075CH) & Cosmic 2½ or Galaxy 2½- 5 lb Extinguisher
	6224P	24	34 3/4	6	26 1/2	36 1/4	25	35 3/4	6 1/8	2 1/2	TBD	2 1/2	HOSE RACK: 1- 1/2" x 1-1/2" Hose Rack Unit - 100' Hose (HRA 100B, HRA100CH) & Cosmic 2½ or Galaxy 2½- 5 lb Extinguisher
	6124P	24	30	8	26 1/2	32 1/2	25	31	8 1/8	4	4	4	HOSE RACK: 2-1/2" x 1-1/2" Hose Rack Unit 50 or 75' Hose (HRA050B-2.5, HRA075B-2.5)
	6424P	24	34 3/4	8	26 1/2	36 1/4	25	35 3/4	8 1/8	4	4	4	HOSE RACK: 2-1/2" x 1-1/2" Hose Rack Unit 100' Hose (HRA100B-2.5)
	6624P	24	38 3/4	8	26 1/2	41 1/4	25	39 3/4	8 1/8	4	4	4	HOSE RACK: 2-1/2" x 1-1/2" Hose Rack Unit 125' Hose (HRA125B-2.5)
	6324P	30	30	8	32 1/2	32 1/2	31	31	8 1/8	4	4	4	HOSE RACK & FD VALVE OR EXTINGUISHER: 1-1/2" OR 2-1/2" Valve 50' or 75' Hose Rack Unit Plus FD Valve or Extinguisher (Not Sentinel 15-20, Nebula)
	6524P	32 3/4	34 3/4	8	35 1/4	36 1/4	33 3/4	35 3/4	8 1/8	4	4	4	HOSE RACK & FD VALVE OR EXTINGUISHER: 1-1/2" OR 2-1/2" Valve, 100' Hose Rack Unit Plus FD Valve or Cosmic or Galaxy Extinguisher
	7224P	32 3/4	38 3/4	8	35 1/4	41 1/4	33 3/4	39 3/4	8 1/8	4	4	4	HOSE RACK & FD VALVE OR EXTINGUISHER: 1-1/2" OR 2-1/2" Valve, 125' Hose Rack Unit Plus FD Valve or Cosmic or Galaxy Extinguisher
	8524P	18	18	8	20 1/2	20 1/2	19	19	8 1/8	4	9	4	FIRE DEPARTMENT VALVE: 1-1/2" or 2-1/2" Fire Department Valve with Cap and Chain
	8424P	18	18	10	20 1/2	20 1/2	19	19	10 1/8	5	9	5	
	8724P	26	26	8	28 1/2	28 1/2	27	27	18 1/8	4	13	4	DUAL SIDE BY SIDE FIRE DEPARTMENT VALVE & EXTINGUISHER OR 2 FIRE DEPARTMENT VALVES: 1-1/2" or 2-1/2" FD Valve w/Cap and Chain Plus Extinguisher - Cosmic & Galaxy 2.5-10, Mercury 2.5-11, Grenadier, Saturn 15-25, Sentinel 5
	8624P	26	26	10	28 1/2	28 1/2	27	27	10 1/8	5	13	5	
	8024P	16	40	9	18 1/2	42 1/2	17	41	9 1/8	4 1/4	6	4 1/4	DUAL EXTINGUISHER & FD VALVE CABINET W/SHELF: Shelf is 12" from bottom. Cosmic or Galaxy Extinguisher